

GaAlAs-IR-Lumineszenzdiode (880 nm) und grüne GaP-LED (565 nm)
GaAlAs-Infrared-Emitter (880 nm) and green GaP-LED (565 nm)
Lead (Pb) Free Product - RoHS Compliant

SFH 7222



Wesentliche Merkmale

- SMT-Gehäuse mit IR-Sender (880 nm) und grünem Sender (565 nm)
- Geeignet für SMT-Bestückung
- Gegurtet lieferbar
- Sender und Empfänger getrennt ansteuerbar

Anwendungen

- Kombination von Anzeigeelement mit:
 - Datenübertragung
 - Fernsteuerung
 - Infrarotschnittstelle

Features

- SMT package with IR emitter (880 nm) and green emitter (565 nm)
- Suitable for SMT assembly
- Available on tape and reel
- Emitter und detector can be controlled separately

Applications

- Combination of display with:
 - data transmission
 - remote control
 - infrared interface

Typ Type	Bestellnummer Ordering Code	Gehäuse Package
SFH 7222	Q65110A2742	SMT Multi TOPLED®

Grenzwerte
Maximum Ratings

Bezeichnung Parameter	Symbol Symbol	Wert Value		Einheit Unit
		IRED	LED	
Betriebstemperatur Operating temperature range	T_{op}	- 40 ... + 100	- 40 ... + 100	°C
Lagertemperatur Storage temperature range	T_{stg}	- 40 ... + 100	- 40 ... + 100	°C
Sperrspannung Reverse voltage	V_R	5	5	V
Durchlassstrom Forward current	I_F (DC)	100	30	mA
Stoßstrom Surge current $t_p \leq 10 \mu s, D = 0$	I_{FSM}	2.5	0.5	A
Verlustleistung Total power dissipation	P_{tot}	180	100	mW
Wärmewiderstand Thermal resistance junction/ambient ¹⁾	$R_{th JA}$	450	500	K/W
Wärmewiderstand Thermal resistance junction/ambient ²⁾	$R_{th JA}$	650		K/W

¹⁾ nur ein Chip betrieben / only one chip on

²⁾ beide Chips betrieben / both chips on

Hinweis/Notes

Die angegebenen Grenzdaten gelten für einen Chip, wenn nicht anders angegeben.
The stated maximum ratings refer to one chip, unless otherwise specified.

Kennwerte ($T_A = 25\text{ °C}$)

Characteristics

Bezeichnung Parameter	Symbol Symbol	Wert Value		Einheit Unit
		IRED	LED	
Wellenlänge der Strahlung Wavelength of peak emission $I_F = 100\text{ mA}$	λ_{peak}	880	565 ($I_F = 10\text{ mA}$)	nm
Dominantwellenlänge Dominant wavelength $I_F = 10\text{ mA}$	λ_{dom}	–	570	nm
Spektrale Bandbreite bei 50% von I_{max} Spectral bandwidth at 50% of I_{max} $I_F = 100\text{ mA}$	$\Delta\lambda$	80	25 ($I_F = 10\text{ mA}$)	nm
Abstrahlwinkel Half angle	φ	± 60	± 60	Grad deg.
Abmessungen der aktiven Chipfläche Dimensions of the active chip area	$L \times B$ $L \times W$	0.4×0.4	0.25×0.25	mm^2
Schaltzeiten Switching times 10%/90%, $I_F = 100\text{ mA}$, $R_L = 50\ \Omega$	t_r, t_f	500	450, 200	ns
Kapazität Capacitance $V_R = 0\text{ V}$, $f = 1\text{ MHz}$	C_o	25	15	pF
Durchlassspannung Forward voltage $I_F = 10\text{ mA}$ $I_F = 100\text{ mA}$, $t_p = 20\text{ ms}$ $I_F = 1\text{ A}$, $t_p = 100\ \mu\text{s}$	V_F	– 1.5 (≤ 1.8) 3.0 (≤ 3.8)	2.0 (≤ 2.6) – –	V
Sperrstrom, $V_R = 5\text{ V}$ Reverse current	I_R	0.01 (≤ 1)	0.01 (≤ 10)	μA
Gesamtstrahlungsfluss Total radiant flux $I_F = 100\text{ mA}$, $t_p = 20\text{ ms}$	Φ_e	23	–	mW
Lichtstärke Luminous intensity $I_F = 2\text{ mA}$	I_V	–	>0.25	mcd
Temperaturkoeffizient von I_e bzw. Φ_e Temperature coefficient of I_e or Φ_e $I_F = 100\text{ mA}$	TC_1	–0.5	–0.3	%/K

Kennwerte ($T_A = 25\text{ °C}$)

Characteristics (cont'd)

Bezeichnung Parameter	Symbol Symbol	Wert Value		Einheit Unit
		IRED	LED	
Temperaturkoeffizient von V_F Temperature coefficient of V_F $I_F = 100\text{ mA}$	TC_V	- 2	- 1.4	mV/K
Temperaturkoeffizient von λ Temperature coefficient of λ $I_F = 100\text{ mA}$	TC_λ	+ 0.25	0.30 (λ_{peak}) 0.07 (λ_{dom})	nm/K

Strahlstärke I_e der IRED in Achsrichtunggemessen bei einem Raumwinkel $\Omega = 0.01\text{ sr}$ Radiant Intensity I_e of the IRED in Axial Directionat a solid angle of $\Omega = 0.01\text{ sr}$

Bezeichnung Description	Symbol Symbol	Werte Values	Einheit Unit
Strahlstärke Radiant intensity $I_F = 100\text{ mA}$, $t_p = 20\text{ ms}$	$I_{e\text{ min.}}$	≥ 4	mW/sr
Strahlstärke Radiant intensity $I_F = 1\text{ A}$, $t_p = 100\text{ }\mu\text{s}$	$I_{e\text{ typ.}}$	48	mW/sr

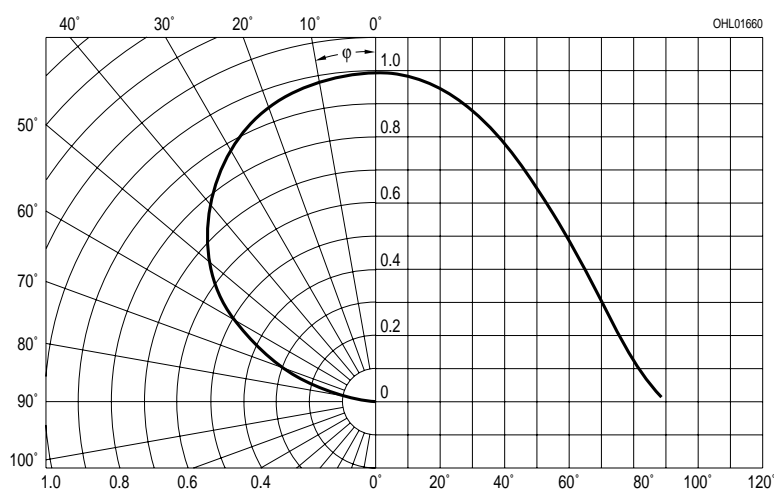
IRED Radiation Characteristics $I_{\text{rel}} = f(\varphi)$ LED Directional Characteristics $S_{\text{rel}} = f(\varphi)$ 

URED

Forward Current $I_F = f(V_F)$

$T_A = 25\text{ }^\circ\text{C}$

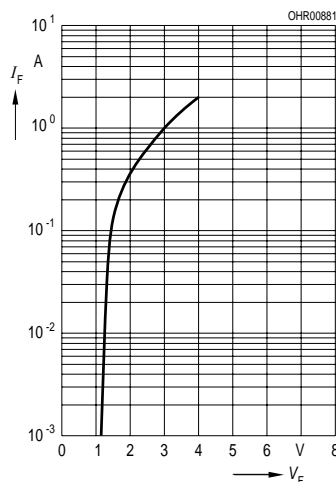

Rel Luminous Intensity

$I_V / I_{V(10\text{ mA})} = f(I_F)$

$T_A = 25\text{ }^\circ\text{C}$

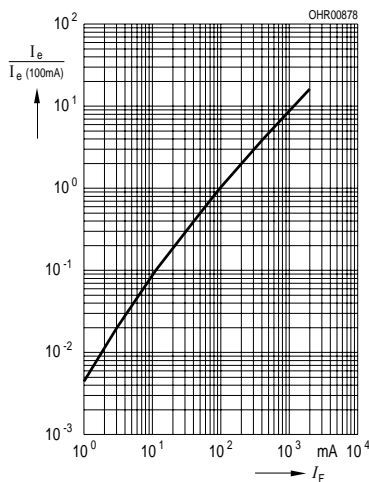

Perm. Pulse Handling Capability

$I_F = f(t_p)$, Duty cycle $D = \text{parameter}$,

$T_A = 25\text{ }^\circ\text{C}$

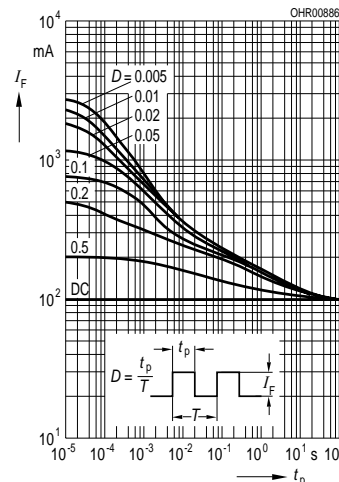

Max. Permissible Forward Current

$I_F = f(T_A)$

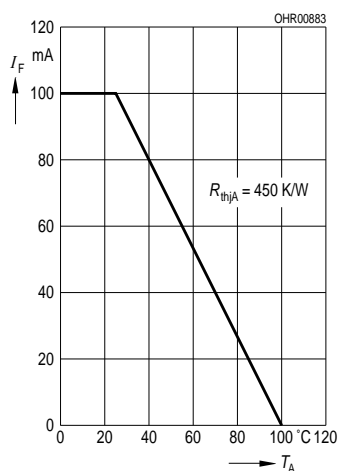

Relative Spectral Emission

$I_{rel} = f(\lambda)$

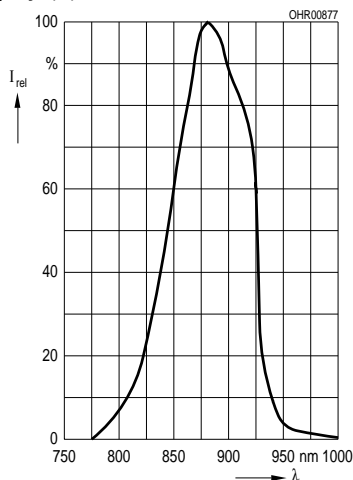

LED

Forward Current $I_F = f(V_F)$
 $T_A = 25\text{ }^\circ\text{C}$

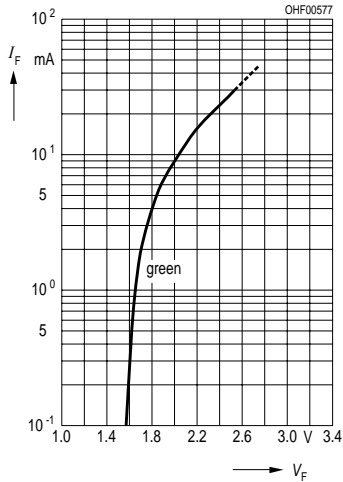

Relative Luminous Intensity $I_V / I_{V(10\text{ mA})} = f(I_F), T_A = 25\text{ }^\circ\text{C}$

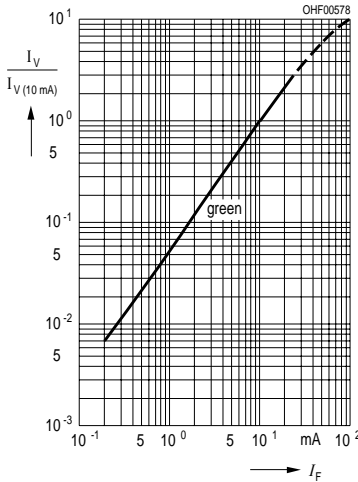

Perm. Pulse Handling Capability $I_F = f(t_p)$
 Duty cycle $D = \text{parameter}, T_A = 25\text{ }^\circ\text{C}$

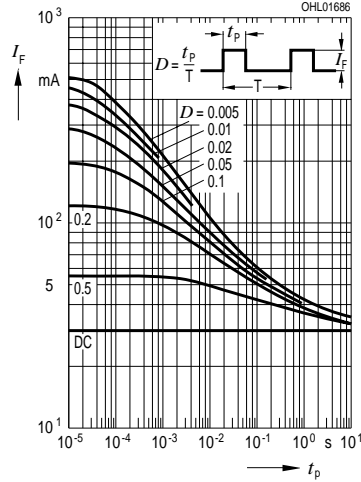

Max. Permissible Forward Current $I_F = f(T_A)$

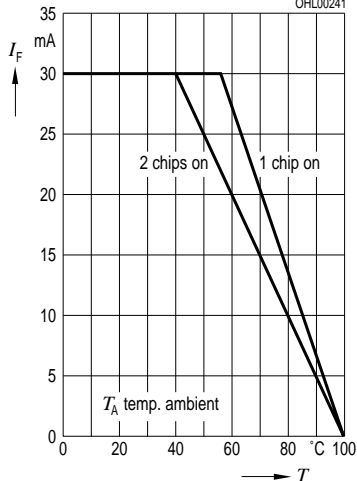

Wavelength at Peak Emission $\lambda_{\text{peak}} = f(T_A), I_F = 10\text{ mA}$

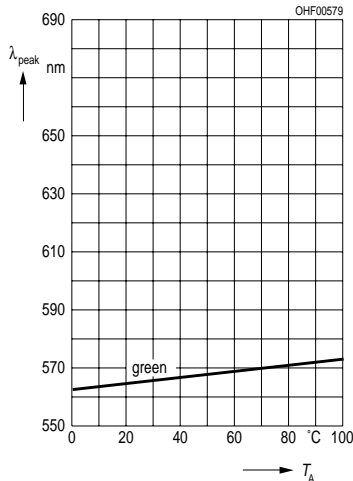

Dominant Wavelength $\lambda_{\text{dom}} = f(T_A), I_F = 10\text{ mA}$

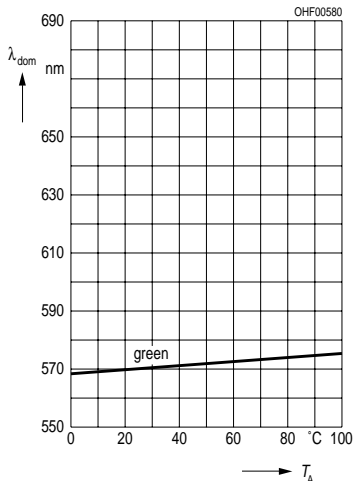

Forward Voltage $V_F = f(T_A)$
 $I_F = f(T_A)$

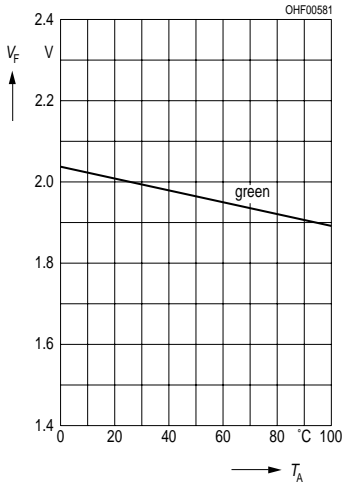

Relative Luminous Intensity $I_V / I_{V(25\text{ }^\circ\text{C})} = f(I_F), I_F = 10\text{ mA}$

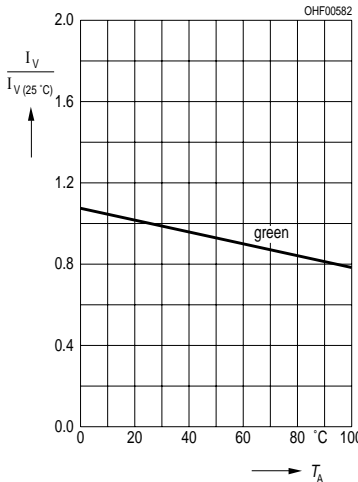

Maßzeichnung Package Outlines

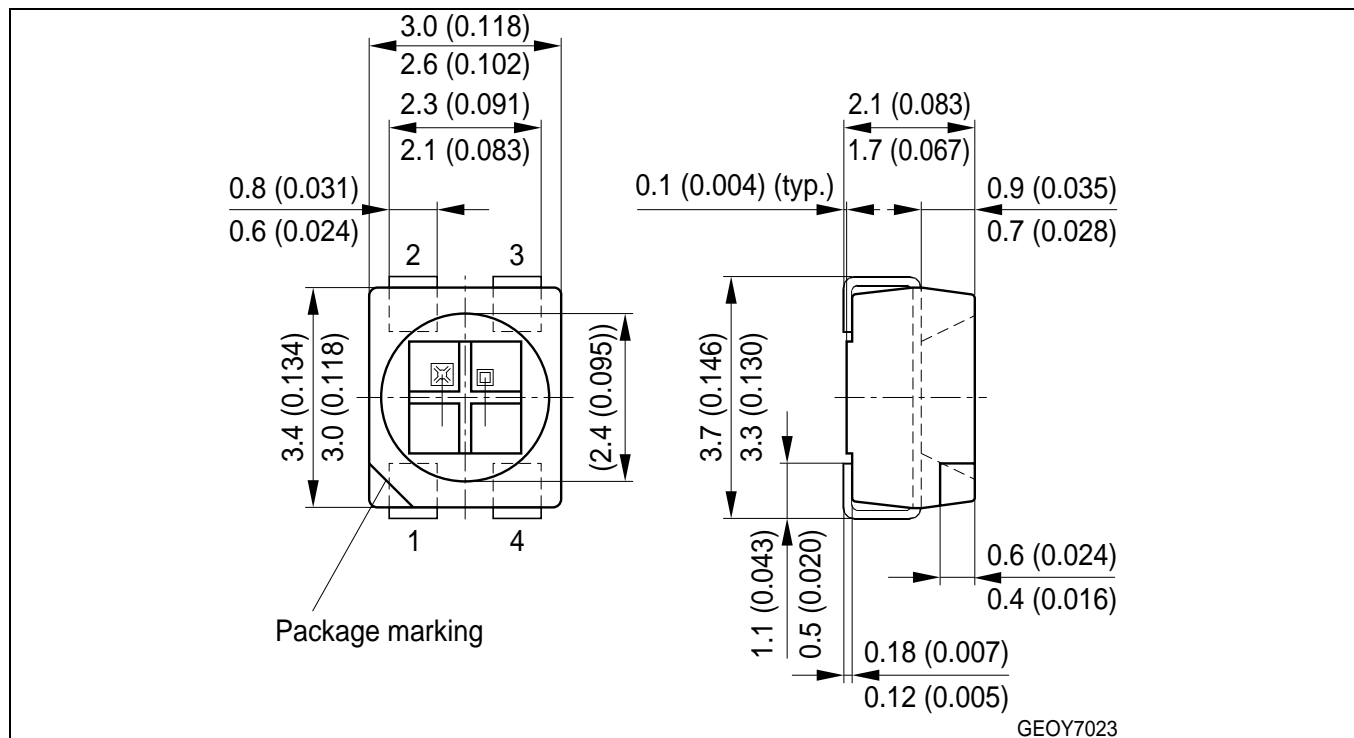

Maße in mm (inch) / Dimensions in mm (inch).

Gehäuse / Package	weiß, klarer Verguss / white, clear resin
Anschlussbelegung pin configuration	1: Kathode (cathode) 880nm 2: Anode (anode) 880nm 3: Kathode (cathode) 565nm 4: Anode (anode) 565nm

Empfohlenes Lötpaddesign
Recommended Solder Pad

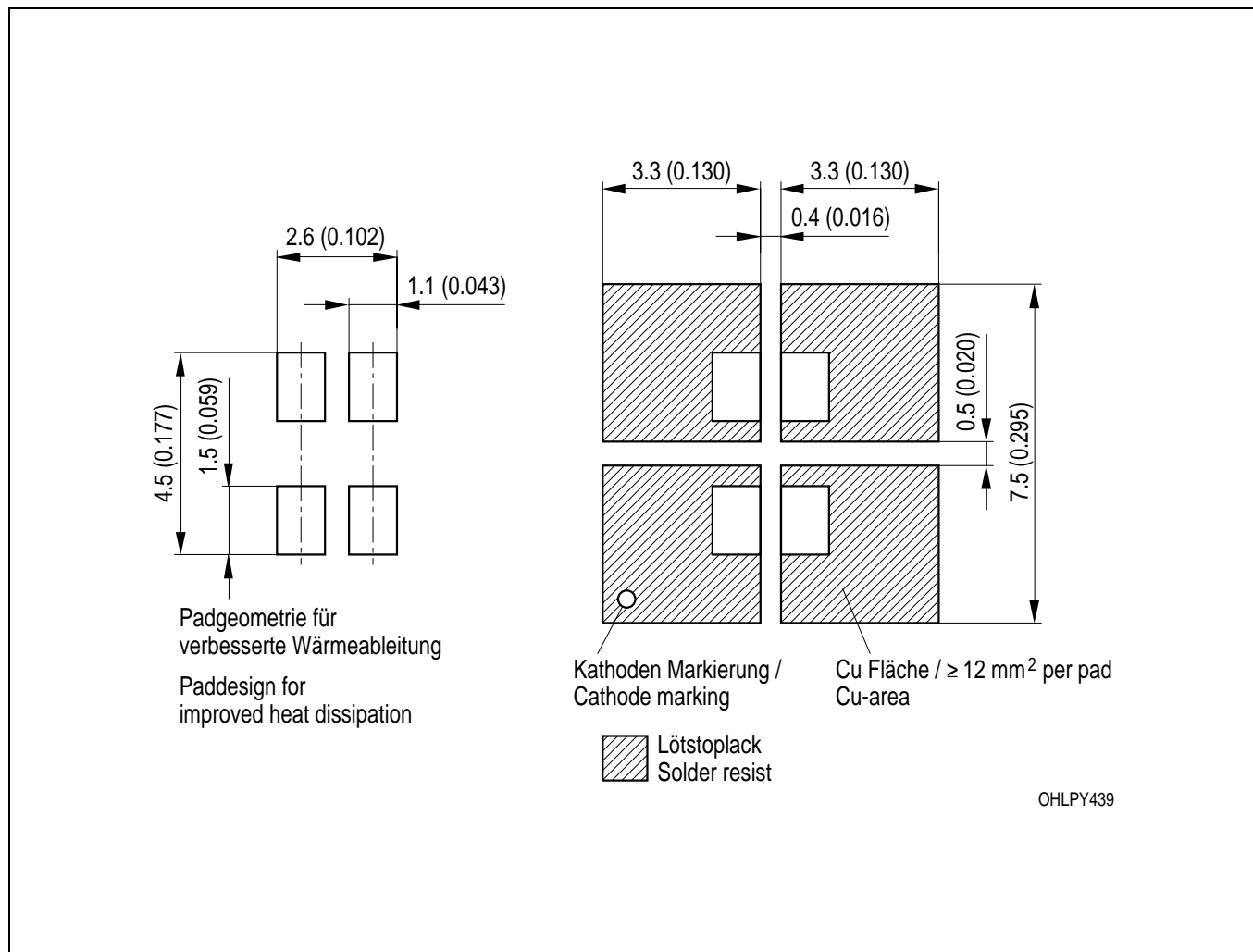

Maße in mm (inch) / Dimensions in mm (inch).

Lötbedingungen
Soldering Conditions
Reflow Lötprofil für bleifreies Löten
Reflow Soldering Profile for lead free soldering

Vorbehandlung nach JEDEC Level 2
 Preconditioning acc. to JEDEC Level 2
 (nach J-STD-020C)
 (acc. to J-STD-020C)

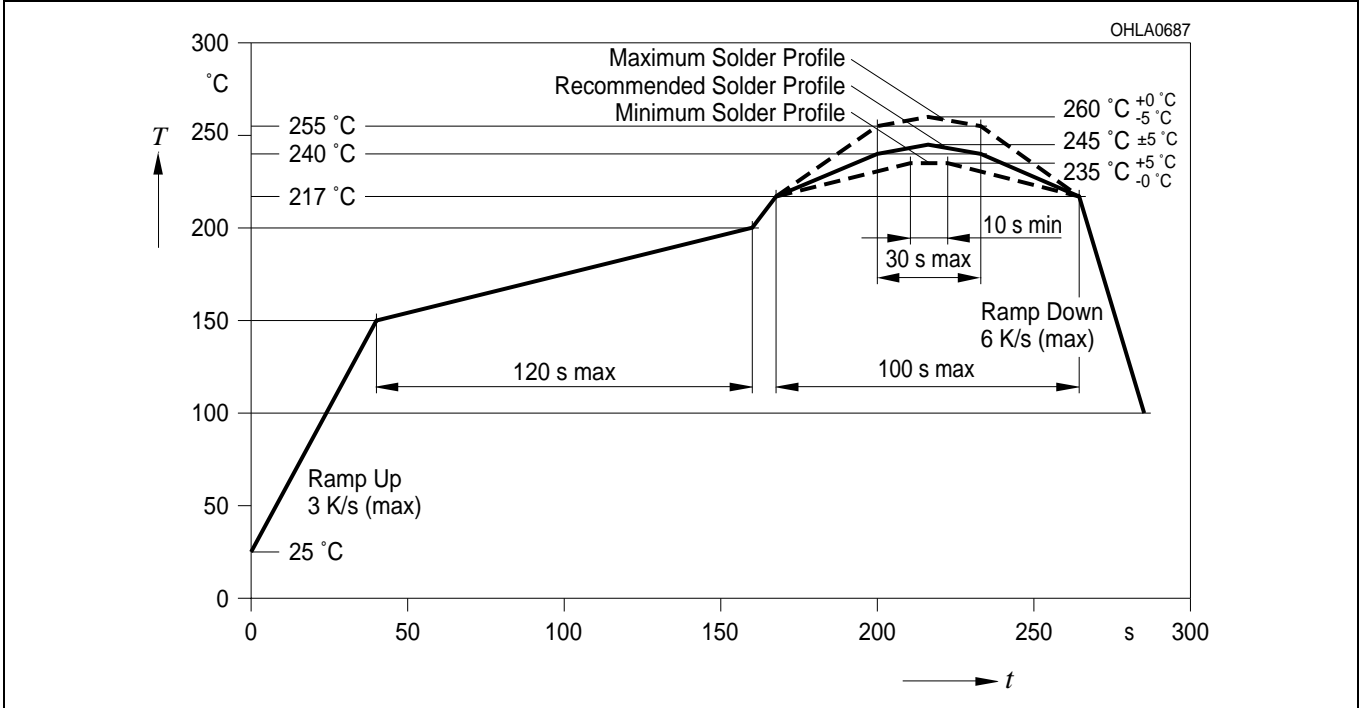

Wellenlöten (TTW)
TTW Soldering

(nach CECC 00802)
 (acc. to CECC 00802)

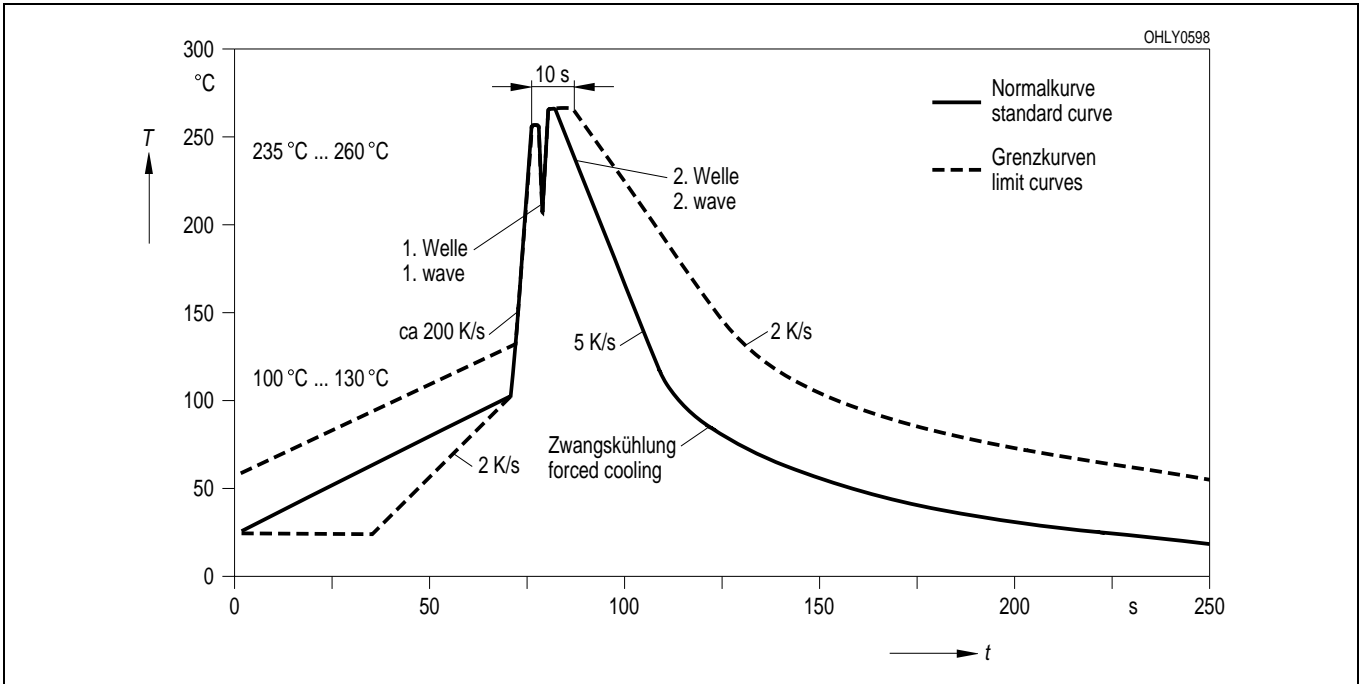

Published by
OSRAM Opto Semiconductors GmbH
Wernerwerkstrasse 2, D-93049 Regensburg
www.osram-os.com
© All Rights Reserved.

EU RoHS and China RoHS compliant product



此产品符合欧盟 RoHS 指令的要求；

按照中国的相关法规和标准，不含有毒有害物质或元素。

The information describes the type of component and shall not be considered as assured characteristics. Terms of delivery and rights to change design reserved. Due to technical requirements components may contain dangerous substances. For information on the types in question please contact our Sales Organization.

Packing

Please use the recycling operators known to you. We can also help you – get in touch with your nearest sales office. By agreement we will take packing material back, if it is sorted. You must bear the costs of transport. For packing material that is returned to us unsorted or which we are not obliged to accept, we shall have to invoice you for any costs incurred.

Components used in life-support devices or systems must be expressly authorized for such purpose! Critical components ¹, may only be used in life-support devices or systems ² with the express written approval of OSRAM OS.

¹ A critical component is a component used in a life-support device or system whose failure can reasonably be expected to cause the failure of that life-support device or system, or to affect its safety or effectiveness of that device or system.

² Life support devices or systems are intended (a) to be implanted in the human body, or (b) to support and/or maintain and sustain human life. If they fail, it is reasonable to assume that the health of the user may be endangered.

Mouser Electronics

Related Product Links

[720-SFH7222-Z - Osram Opto Semiconductor SFH 7222-Z](#)